

TVS Diodes

Transient Voltage Suppression Diodes

SMA6J Series



Description

Transient Voltage Suppressor (TVS) is a circuit protection component that either attenuates (reduces) or filters a transient voltage spike (overvoltage), TVS diodes provide critical protection by going into avalanche breakdown within no more than a few nanoseconds after a strike, clamping the transient voltage, and routing its current to the ground.

Applications

- Communication Equipment
- Security & Protection
- Industrial Control Equipment
- Power Supply
- Automotive Electronics
- New Energy
- Lightning Protection

Functional Diagram



Uni-Directional



Bi-Directional

Features

- Low incremental surge resistance
- Excellent clamping capability
- Low profile package with built-in strain relief
- Typical I_R less than 1.0 μA above 10 V
- 600 W peak pulse power capability with a 10/1000 μs Waveform
- For surface mounted applications to optimize board space
- Typical failure mode is short from over-specified voltage or current
- IEC 61000-4-2 ESD 30 kV (Air), 30 kV (Contact)
- EFT protection of data lines in accordance with IEC 61000-4-4
- Very fast response time
- High temperature to reflow soldering guaranteed: 260 $^{\circ}C/30$ sec
- Plastic package is flammability rated V-0 per Underwriters Laboratories
- Meet MSL level1, per J-STD-020
- Matte tin lead-free plated
- Halogen free and RoHS compliant
- Pb-free E3 means 2nd level interconnect is Pb-free and the terminal finish material is tin(Sn) (IPC/JEDEC J-STD-609A.01)

Package Outline Dimensions (DO-214AC)

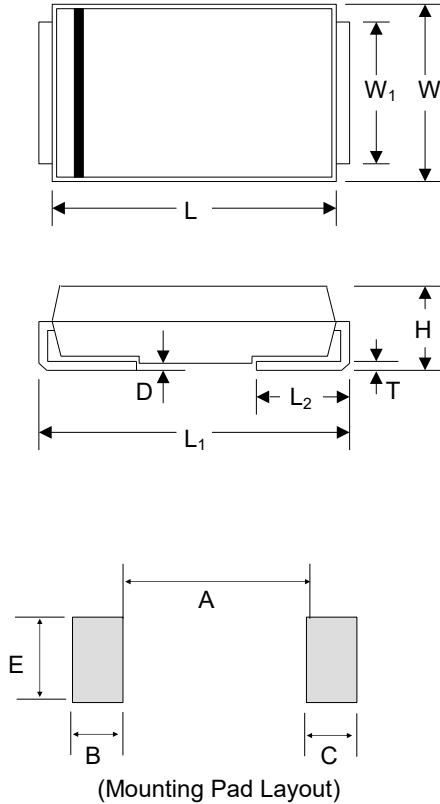

Symbol	Millimeters		Inches	
	Min.	Max.	Min.	Max.
L	3.99	4.60	0.157	0.181
W	2.30	2.79	0.095	0.110
W ₁	1.25	1.65	0.049	0.065
H	1.90	2.44	0.075	0.096
T	0.152	0.305	0.006	0.012
L ₁	4.80	5.28	0.189	0.208
L ₂	0.78	1.52	0.030	0.060
D	-	0.203	-	0.008
A	-	2.30	-	0.090
B	2.10	-	0.082	-
C	2.10	-	0.082	-
E	1.80	-	0.070	-

Maximum Ratings and Characteristics

(Ratings at 25°C ambient temperature unless otherwise specified.)

Parameter	Symbol	Value	Unit
Peak Power Dissipation with a 10/1000 μs waveform ⁽¹⁾⁽²⁾ (Fig.2)	P _{PPM}	600	W
Peak Power Dissipation on Infinite Heat Sink at T _L =50 °C	P _D	3.3	W
Peak Forward Surge Current,8.3 ms single half sinewave superimposed on rated load (JEDEC Method) ⁽³⁾	I _{FSM}	60	A
Maximum Instantaneous Forward Voltage at 25 A for Unidirectional Only	V _F	3.5	V
Operating Temperature Range	T _J	-55 to 150	°C
Storage Temperature Range	T _{STG}	-55 to 150	°C
Typical Thermal Resistance Junction to Lead	R _{θJL}	30	°C / W
Typical Thermal Resistance Junction to Ambient	R _{θJA}	120	°C / W

Notes

1. Non-repetitive current pulse, per Fig. 4 and derated above T_J(initial)=25 °C per Fig. 3.
2. Mounted on 5.0 x 5.0 mm copper pad to each terminal.
3. Measured on 8.3 ms single half sine wave or equivalent square wave for unidirectional device only.

TVS Diodes

Transient Voltage Suppression Diodes

SMA6J Series

Part Numbering System

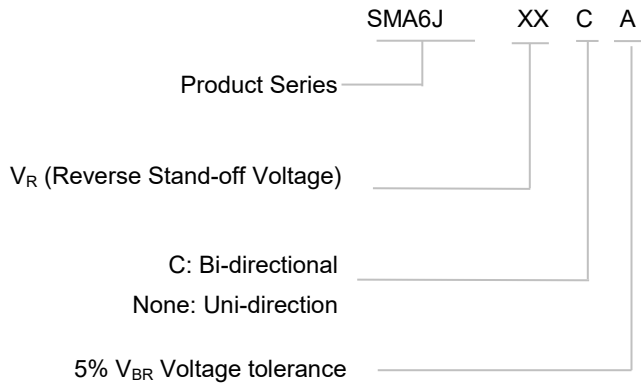

Marking

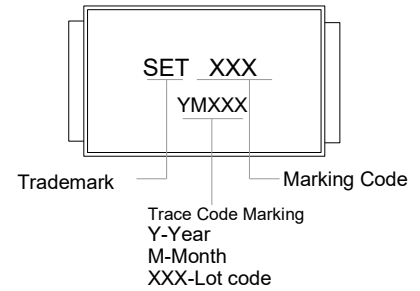
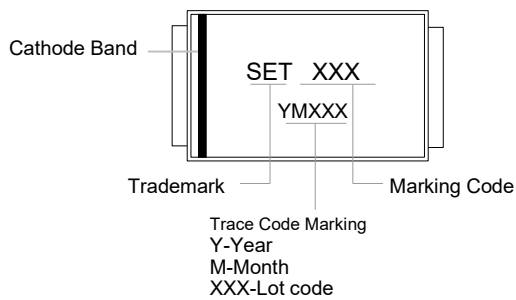

TVS Diodes

Transient Voltage Suppression Diodes

SMA6J Series

Electrical Characteristics (T_A=25 °C unless otherwise noted)

Part Number		Device Marking Code		Breakdown Voltage V _{BR} @I _T		Test Current I _T	Reverse Stand-off Voltage V _R	Max. Reverse Leakage I _R @V _R	Max. Peak Pulse Current I _{PPM}	Max. Clamping Voltage V _C @I _{PPM}
				Min	Max					
Uni	Bi	Uni	Bi	(V)		(mA)	(V)	(μA)	(A)	(V)
SMA6J5.0A	SMA6J5.0CA	KE	AE	6.40	7.00	10	5.00	400.00	65.30	9.20
SMA6J6.0A	SMA6J6.0CA	KG	AG	6.67	7.37	10	6.00	400.00	58.30	10.30
SMA6J6.5A	SMA6J6.5CA	KK	AK	7.22	7.98	10	6.50	250.00	53.60	11.20
SMA6J7.0A	SMA6J7.0CA	KM	AM	7.78	8.60	10	7.00	100.00	50.00	12.00
SMA6J7.5A	SMA6J7.5CA	KP	AP	8.33	9.21	1	7.50	50.00	46.60	12.90
SMA6J8.0A	SMA6J8.0CA	KR	AR	8.89	9.83	1	8.00	25.00	44.20	13.60
SMA6J8.5A	SMA6J8.5CA	KT	AT	9.44	10.40	1	8.50	10.00	41.70	14.40
SMA6J9.0A	SMA6J9.0CA	KV	AV	10.00	11.10	1	9.00	10.00	39.00	15.40
SMA6J10A	SMA6J10CA	KX	AX	11.10	12.30	1	10.00	5.00	35.30	17.00
SMA6J11A	SMA6J11CA	KZ	AZ	12.20	13.50	1	11.00	1.00	33.00	18.20
SMA6J12A	SMA6J12CA	LE	BE	13.30	14.70	1	12.00	1.00	30.20	19.90
SMA6J13A	SMA6J13CA	LG	BG	14.40	15.90	1	13.00	1.00	28.00	21.50
SMA6J14A	SMA6J14CA	LK	BK	15.60	17.20	1	14.00	1.00	25.90	23.20
SMA6J15A	SMA6J15CA	LM	BM	16.70	18.50	1	15.00	1.00	24.60	24.40
SMA6J16A	SMA6J16CA	LP	BP	17.80	19.70	1	16.00	1.00	23.10	26.00
SMA6J17A	SMA6J17CA	LR	BR	18.90	20.90	1	17.00	1.00	21.80	27.60
SMA6J18A	SMA6J18CA	LT	BT	20.00	22.10	1	18.00	1.00	20.60	29.20
SMA6J20A	SMA6J20CA	LV	BV	22.20	24.50	1	20.00	1.00	18.60	32.40
SMA6J22A	SMA6J22CA	LX	BX	24.40	26.90	1	22.00	1.00	16.90	35.50
SMA6J24A	SMA6J24CA	LZ	BZ	26.70	29.50	1	24.00	1.00	15.50	38.90
SMA6J26A	SMA6J26CA	ME	CE	28.90	31.90	1	26.00	1.00	14.30	42.10
SMA6J28A	SMA6J28CA	MG	CG	31.10	34.40	1	28.00	1.00	13.30	45.40
SMA6J30A	SMA6J30CA	MK	CK	33.30	36.80	1	30.00	1.00	12.40	48.40
SMA6J33A	SMA6J33CA	MM	CM	36.70	40.60	1	33.00	1.00	11.30	53.30
SMA6J36A	SMA6J36CA	MP	CP	40.00	44.20	1	36.00	1.00	10.40	58.10
SMA6J40A	SMA6J40CA	MR	CR	44.40	49.10	1	40.00	1.00	9.30	64.50
SMA6J43A	SMA6J43CA	MT	CT	47.80	52.80	1	43.00	1.00	8.70	69.40
SMA6J45A	SMA6J45CA	MV	CV	50.00	55.30	1	45.00	1.00	8.30	72.70
SMA6J48A	SMA6J48CA	MX	CX	53.30	58.90	1	48.00	1.00	7.80	77.40
SMA6J51A	SMA6J51CA	MZ	CZ	56.70	62.70	1	51.00	1.00	7.30	82.40
SMA6J54A	SMA6J54CA	NE	DE	60.00	66.30	1	54.00	1.00	6.90	87.10

TVS Diodes

Transient Voltage Suppression Diodes

SMA6J Series

Part Number		Device Marking Code		Breakdown Voltage $V_{BR}@I_T$		Test Current I_T	Reverse Stand-off Voltage V_R	Max. Reverse Leakage $I_R@V_R$	Max. Peak Pulse Current I_{PPM}	Max. Clamping Voltage $V_C@I_{PPM}$
				Min	Max					
Uni	Bi	Uni	Bi	(V)		(mA)	(V)	(μ A)	(A)	(V)
SMA6J58A	SMA6J58CA	NG	DG	64.40	71.20	1	58.00	1.00	6.50	93.60
SMA6J60A	SMA6J60CA	NK	DK	66.70	73.70	1	60.00	1.00	6.20	96.80
SMA6J64A	SMA6J64CA	NM	DM	71.10	78.60	1	64.00	1.00	5.90	103.00
SMA6J70A	SMA6J70CA	NP	DP	77.80	86.00	1	70.00	1.00	5.30	113.00
SMA6J75A	SMA6J75CA	NR	DR	83.30	92.10	1	75.00	1.00	5.00	121.00
SMA6J78A	SMA6J78CA	NT	DT	86.70	95.80	1	78.00	1.00	4.80	126.00
SMA6J85A	SMA6J85CA	NV	DV	94.40	104.00	1	85.00	1.00	4.40	137.00
SMA6J90A	SMA6J90CA	NX	DX	100.00	111.00	1	90.00	1.00	4.10	146.00
SMA6J100A	SMA6J100CA	NZ	DZ	111.00	123.00	1	100.00	1.00	3.70	162.00
SMA6J110A	SMA6J110CA	PE	EE	122.00	135.00	1	110.00	1.00	3.40	177.00
SMA6J120A	SMA6J120CA	PG	EG	133.00	147.00	1	120.00	1.00	3.10	193.00
SMA6J130A	SMA6J130CA	PK	EK	144.00	159.00	1	130.00	1.00	2.90	209.00
SMA6J150A	SMA6J150CA	PM	EM	167.00	185.00	1	150.00	1.00	2.50	243.00
SMA6J160A	SMA6J160CA	PP	EP	178.00	197.00	1	160.00	1.00	2.30	259.00
SMA6J170A	SMA6J170CA	PR	ER	189.00	209.00	1	170.00	1.00	2.20	275.00
SMA6J180A	SMA6J180CA	PT	ET	201.00	222.00	1	180.00	1.00	2.10	292.00
SMA6J188A	SMA6J188CA	PB	EB	209.00	231.00	1	188.00	1.00	2.00	304.00
SMA6J200A	SMA6J200CA	PV	EV	224.00	247.00	1	200.00	1.00	1.90	324.00
SMA6J220A	SMA6J220CA	PX	EX	246.00	272.00	1	220.00	1.00	1.70	356.00
SMA6J250A	SMA6J250CA	PZ	EZ	279.00	309.00	1	250.00	1.00	1.50	405.00

Notes:

1. For bidirectional type having V_R of 10 volts and less, the I_R should be doubled.
2. For parts without A in the PN, the V_{BR} tolerance is $\pm 10\%$ and V_C is 5% higher than parts with A. The parts without A are currently available, but not recommended for new designs. The parts with A are preferred.
3. $V_F < 3.5$ V for single die parts.

TVS Diodes

Transient Voltage Suppression Diodes

SMA6J Series

I-V Curve Characteristics

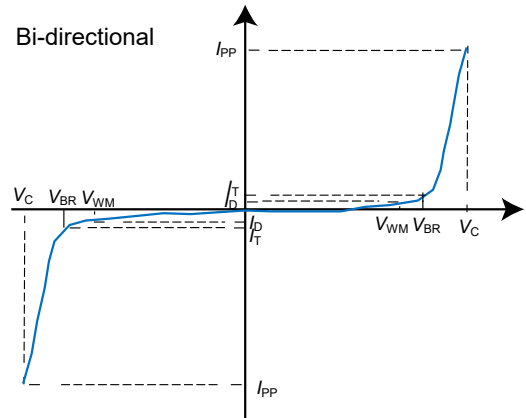
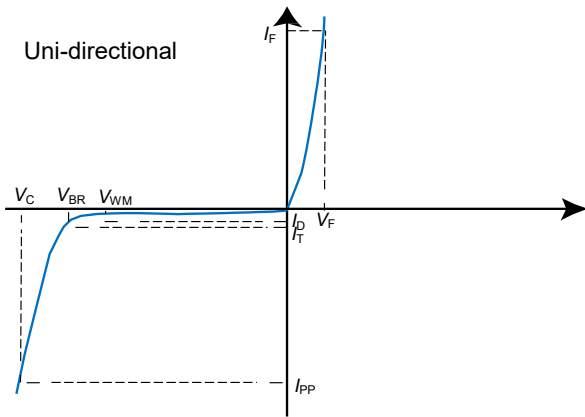

Performance Curve for Reference ($T_A=25^\circ\text{C}$ unless otherwise noted)

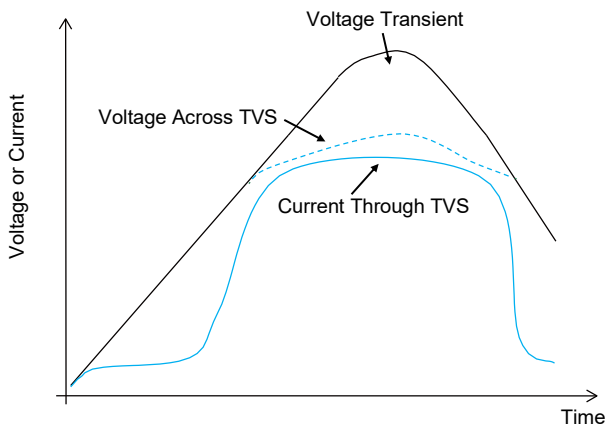

FIGURE 1 TVS Transients Clamping Waveform

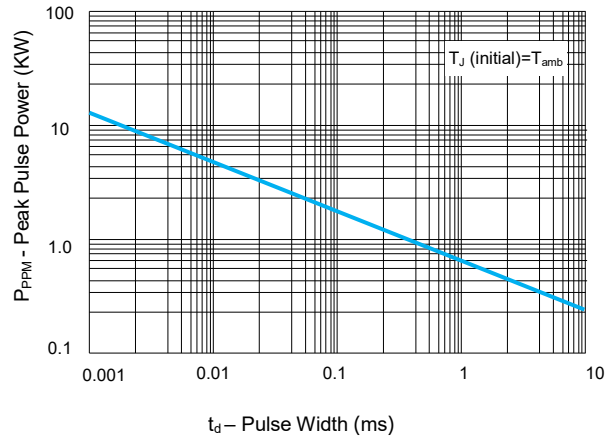

FIGURE 2 Peak Pulse Power Rating Curve

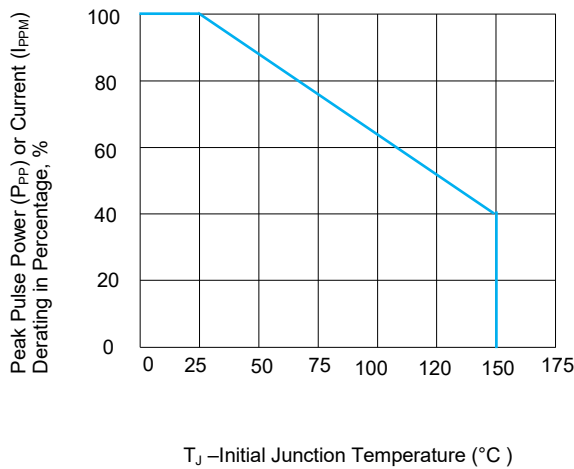

FIGURE 3 Peak Pulse Power Derating Curve

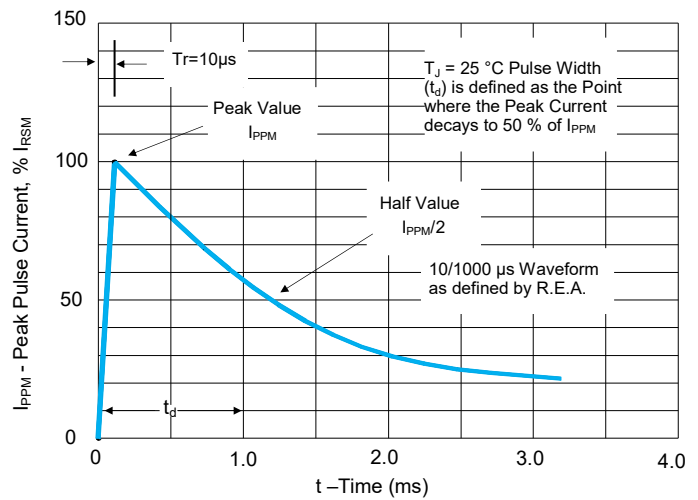

FIGURE 4 Pulse Waveform

TVS Diodes

Transient Voltage Suppression Diodes

SMA6J Series

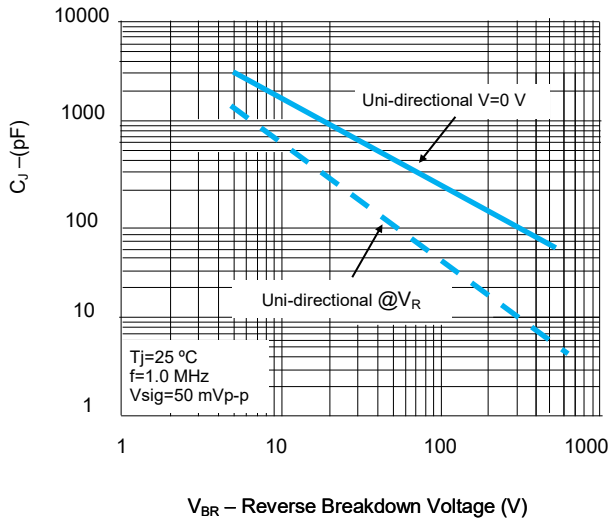

FIGURE 5 Typical Junction Capacitance

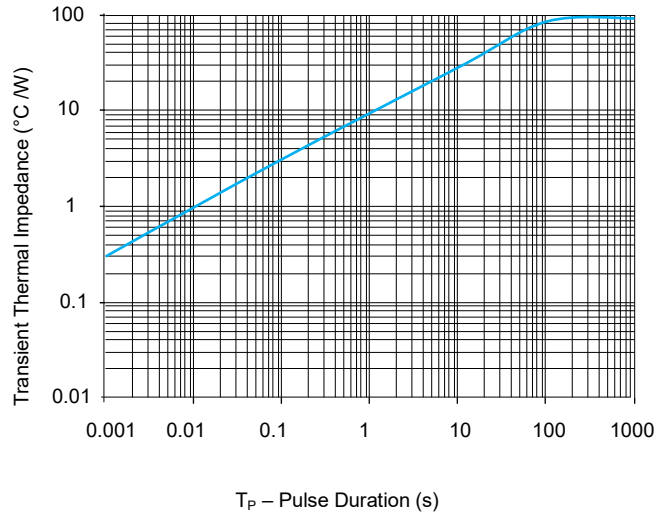

FIGURE 6 Typical Transient Thermal Impedance

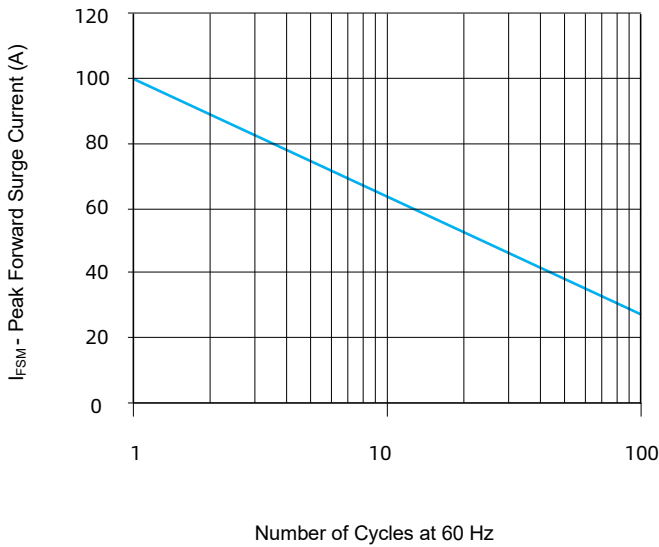

FIGURE 7 Maximum Non-Repetitive Forward Surge Current Uni-Directional only

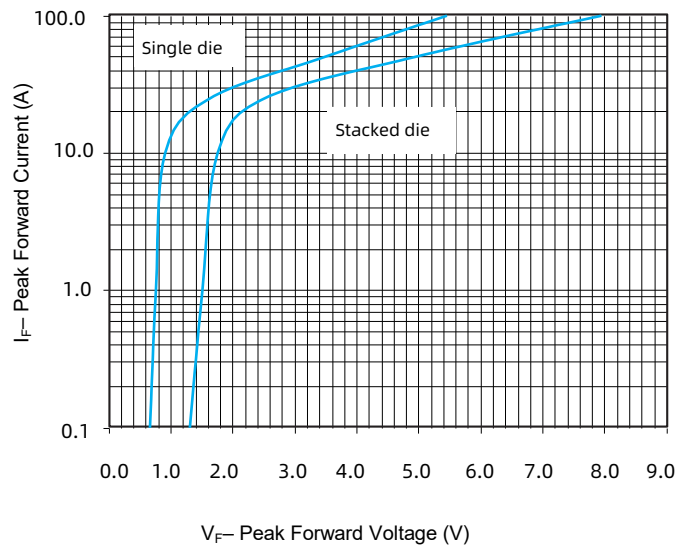

FIGURE 8 Peak Forward Drop vs Peak Forward Current (Typical Values)

Environmental Specifications

High Temp. Storage	JESD22-A103
HTRB	JESD22-A108
Temperature Cycling	JESD22-A104
MSL	JESDEC-J-STD-020, Level 1
H3TRB	JESD22-A101
RSH	JESD22-A111

Physical Specifications

Weight	0.003 ounce, 0.093 grams
Case	JESD22DO214AA. Molded plastic body over glass passivated junction
Polarity	Color band denotes positive end (cathode) except Bidirectional
Terminal	Matte Tin-plated leads, Solderability per JESD22-B102

Soldering Parameters

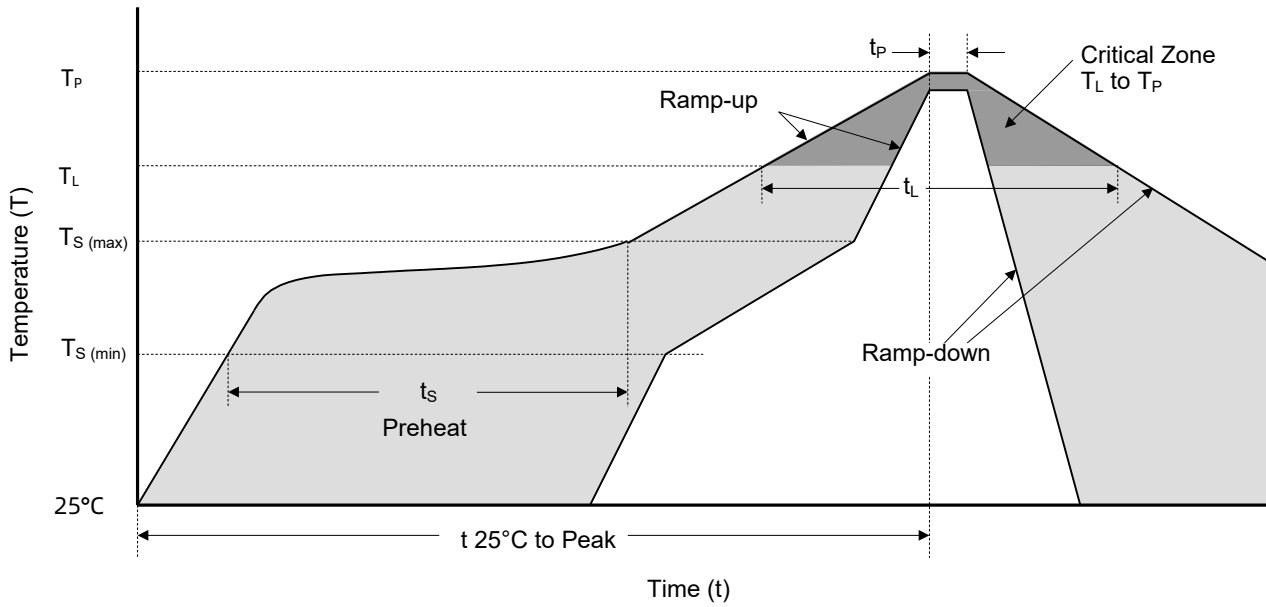

Reflowing Condition

Reflow Soldering Parameters		Lead-Free Assembly
Pre-heat	Temperature Min ($T_{S (min)}$)	150 °C
	Temperature Max ($T_{S (max)}$)	200 °C
	Time (min to max) (t_s)	60 ~ 120 seconds
Average Ramp Up Rate (Liquidus Temp (T_L) to Peak)		3 °C / second max.
$T_{S (max)}$ to T_L Ramp-up Rate		3 °C / second max.
Reflow	Temperature (T_L) (Liquidus)	217 °C
	Time (min to max) (t_L)	60 ~ 150 seconds
Peak Temperature (T_P)		260 ^{+0/-5} °C
Time of within 5 °C of Actual Peak Temperature (t_p)		20 ~ 40 seconds
Ramp-down Rate		6 °C / second max.
Time from 25 °C to Peak Temperature		8 Minutes max.
Do Not Exceed		260 °C

TVS Diodes

Transient Voltage Suppression Diodes

SMA6J Series

Packaging Information

Tape	Symbol	Dimension (mm)
	W	12.00±0.30/-0.10
	P ₀	4.00±0.10
	P ₁	8.00±0.10
	P ₂	2.00±0.05
	D ₀	1.55±0.05
	D ₁	1.55±0.05
	E	1.75±0.1
	F	5.50±0.05
	A ₀	2.79 ± 0.10
	B ₀	5.33 ± 0.10
	K ₀	2.36 ± 0.10
	T	0.30 ± 0.05

Reel Size	13" Reel	
	A	330 mm
	C	13.2 mm
	W ₁	12.5 mm

Part Number	Package	QTY (Reel)	Packaging Option	Packaging Specification
SMA6Jxxx	DO-214AC	5000 PCS	Tape & Reel – 12 mm tape/13" reel	EIA STD RS-481

Glossary

Item	Description
V_C	Clamping Voltage Voltage across TVS in a region of low differential resistance that serves to limit the voltage across the device terminals.
V_R	Reverse Stand-off Voltage Maximum voltage that can be applied to the TVS without operation. NOTE : It is also shown as V_{WM} (maximum working voltage (maximum d.c. voltage)) and known as rated stand-off voltage (V_{so}).
I_R	Reverse Leakage Current Current measured at V_R . NOTE : Also shown as I_D for stand-by current.
V_{BR}	Breakdown Voltage Voltage across TVS at a specified current I_T in the breakdown region.
I_{PPM}	Rated Random Recurring Peak Impulse Current Maximum-rated value of random recurring peak impulse current that may be applied to a device.
$P_{M(AV)}$	Rated Average Power Dissipation Maximum-rated value of power dissipation resulting from all sources, including transients and standby current, averaged over a short period of time.
P_{PPM}	Rated Random Recurring Peak Impulse Power Dissipation Maximum-rated value of the product of rated random recurring peak impulse current (I_{PPM}) multiplies by specified maximum clamping voltage (V_C).
C_J	Capacitance Capacitance across the TVS measured at a specified frequency and voltage.
V_{FS}	Peak Forward Surge Voltage Peak voltage across an TVS for a specified forward surge current (I_{FS}) and time duration. NOTE : Also shown as V_F .
I_{FS}	Forward Surge Current Pulsed current through TVS in the forward conducting region. NOTE : Also shown as I_F .
$\alpha_{V(BR)}$	Temperature Coefficient of Breakdown Voltage The change of breakdown voltage divided by the change of temperature.
I_{PP}	Peak pulse Current Peak pulse current value applied across the TVS to determine the clamping voltage V_C for a specified wave shape.
I_T	Pulsed D.C. Test Current Test current for measurement of the breakdown voltage V_{BR} . This is defined by the manufacturer and usually given in milliamperes with a pulse duration of less than 40 ms. NOTE : Also shown as I_{BR} .

—(GB-T 18802.321 / IEC 61643-321 / JESD210A)



ATTENTION

Usage

1. TVS must be operated in the specified ambient temp.
2. Do not clean the TVS with strong polar solvent such as ketone, esters, benzene and halogenated hydrocarbon, to avoid damaging the encapsulating layer.
3. Please do not apply severe vibration, shock or pressure to TVS, to avoid element cracking.

Replacement

1. If TVS is visually damaged, please replace it.
2. TVS is a non-repairable product. For safety sake, please use equivalent TVS for replacement.

Storage

1. Storage Temp. Range: (-55 to 150) °C.
2. Do not store the TVS at the high temp., high humidity or corrosive gas environment, to avoid influencing the solder-ability of the lead wires. The product shall be used up within 1 year after receiving the goods.

Environmental Conditions

1. TVS should not be exposed to the open air, nor direct sunshine.
2. TVS should avoid rain, water vapor or other condition of high temp. and high humidity.
3. TVS should avoid sand dust, salt mist, or other harmful gases.

Max. Typical Capacitance of TVS

The typical capacitance of TVS is listed in the specifications. Designers may refer to it when designing TVS in High frequency circuit.

Installation Mechanical Stress

1. Do not knock TVS when installing, to avoid mechanical damage.
2. Please do not apply severe vibration, shock or pressure to TVS, to avoid surface resin or element cracking.

Transient Voltage Suppressor (Surface Mount) Features Overview

Package Type										Series
DO-221AC	○	○	○	○	○	SMA6L	○	○	○	
DO-214AA	○	○	○	○	○	○	SACB	SMBJ	P6SMB	
DO-214AB	○	○	○	○	○	○	○	○	○	
DO-214AC	○	○	SMAJ	P4SMA	SMA6J	○	○	○	○	
SOD-123FL	SMF	P4SMF	○	○	○	○	○	○	○	
SMT0-218	○	○	○	○	○	○	○	○	○	
Product Outline (mm)										
V_R / V_{WM} (V) Reverse Stand-off Voltage	5.0 ~ 250	5.0 ~ 85	5.0 ~ 440	5.8 ~ 468	5.0 ~ 250	5.0 ~ 50	5.0 ~ 440	5.8 ~ 512		
P_{PPM} (W) (10/1000 μ s) Rated Peak ImPulse Power Dissipation	200		400		600	500	600			
I_{PPM} (kA) (8/20 μ s) Rated Peak ImPulse Current	○									
Operating Temperature (°C)	-55 to +150									

Transient Voltage Suppressor (Surface Mount) Features Overview

Package Type	Series									
	DO-221AC	DO-214AA	DO-214AB	DO-214AC	SOD-123FL	SMT0-218	SPC1	SPC3	SPC6	SPC10
	○	○	○	○	○	○	○	○	○	○
	○	○	○	○	○	○	○	○	○	○
	SMCJ	1.5SMC	3.0SMCJ	SMDJ	5.0SMDJ					
	○	○	○	○	○					
	○	○	○	○	○					
	○	○	○	○	○	SPC1	SPC3	SPC6	SPC10	
Product Outline (mm)										
V_R / V_{WM} (V) Reverse Stand-off Voltage	5.0 ~ 440	5.8 ~ 512	5.0 ~ 440	12 ~ 170	380 / 430	66	58 ~ 76	58 ~ 86		
P_{PPM} (W) (10/1000 μ s) Rated Peak ImPulse Power Dissipation	1500	3000	5000							
I_{PPM} (kA)(8/20 μs) Rated Peak ImPulse Current						1	3	6	10	
Operating Temperature (°C)		-55 to +150					-55 to +125			

Transient Voltage Suppressor (Axial Lead) Features Overview

Package Type	Series																
	DO-201	DO-41	DO-15	P600	Radial lead	1.5KE	LCE										
	○	○	○	○	○	○	○	○	○	○	○	○	○	○	○	○	
	P4KE	○	○	○	○	○	○	○	○	○	○	○	○	○	○	○	
	○	SAC	P6KE	○	○	○	○	○	○	○	○	○	○	○	○	○	
	○	○	○	○	○	○	○	5KP	15KPA	20KPA	30KPA	○	○	○	○	○	
	○	○	○	○	○	○	○	○	○	○	○	SPCL1	SPCL3	SPCL6	SPCL10	SPCL15	SPCL20
Product Outline (mm)																	
V_R / V_{WM} (V) Reverse Stand-off Voltage	5.8 ~ 468	5.0 ~ 50	5.8 ~ 512	5.8 ~ 512	6.5 ~ 90	5.0 ~ 250	17 ~ 280	20 ~ 300	28 ~ 360	76	15 ~ 430	30 ~ 430	15 ~ 530	58 ~ 380	16 ~ 76		
P_{PPM} (W) (10/1000 μ s) Rated Peak ImPulse Power Dissipation	400	500	600	1500	5000	15000	20000	30000					○				
I_{PPM} (kA)(8/20 μ s) Rated Peak ImPulse Current					○					1	3	6	10	15	20		
Operating Temperature (°C)					-55 to +150											-55 to +125	